

WARP2 SERIES IGBT WITH
 ULTRAFAST SOFT RECOVERY DIODE

Applications

- Telecom and Server SMPS
- PFC and ZVS SMPS Circuits
- Uninterruptable Power Supplies
- Consumer Electronics Power Supplies

Features

- NPT Technology, Positive Temperature Coefficient
- Lower $V_{CE(SAT)}$
- Lower Parasitic Capacitances
- Minimal Tail Current
- HEXFRED Ultra Fast Soft-Recovery Co-Pack Diode
- Tighter Distribution of Parameters
- Higher Reliability

Benefits

- Parallel Operation for Higher Current Applications
- Lower Conduction Losses and Switching Losses
- Higher Switching Frequency up to 150kHz

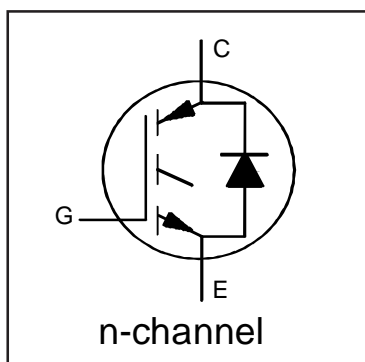

$V_{CES} = 600V$
$V_{CE(on)} \text{ typ.} = 1.85V$ @ $V_{GE} = 15V$ $I_C = 22A$
Equivalent MOSFET Parameters ①
$R_{CE(on)} \text{ typ.} = 84m\Omega$
I_D (FET equivalent) = 35A

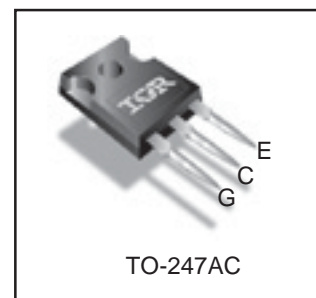
**Absolute Maximum Ratings**

	Parameter	Max.	Units
V_{CES}	Collector-to-Emitter Voltage	600	V
$I_C @ T_C = 25^\circ C$	Continuous Collector Current	60	A
$I_C @ T_C = 100^\circ C$	Continuous Collector Current	34	
I_{CM}	Pulse Collector Current (Ref. Fig. C.T.4)	120	
I_{LM}	Clamped Inductive Load Current ②	120	
$I_F @ T_C = 25^\circ C$	Diode Continuous Forward Current	40	
$I_F @ T_C = 100^\circ C$	Diode Continuous Forward Current	15	
I_{FRM}	Maximum Repetitive Forward Current ③	60	
V_{GE}	Gate-to-Emitter Voltage	± 20	
$P_D @ T_C = 25^\circ C$	Maximum Power Dissipation	308	W
$P_D @ T_C = 100^\circ C$	Maximum Power Dissipation	123	
T_J	Operating Junction and	-55 to +150	$^\circ C$
T_{STG}	Storage Temperature Range		
	Soldering Temperature for 10 sec.		
	Mounting Torque, 6-32 or M3 Screw	10 lbf-in (1.1 N-m)	

Thermal Resistance

	Parameter	Min.	Typ.	Max.	Units
$R_{\theta JC}$ (IGBT)	Thermal Resistance Junction-to-Case (each IGBT)	—	—	0.41	$^\circ C/W$
$R_{\theta JC}$ (Diode)	Thermal Resistance Junction-to-Case (each Diode)	—	—	1.7	
$R_{\theta CS}$	Thermal Resistance, Case-to-Sink (flat, greased surface)	—	0.24	—	
$R_{\theta JA}$	Thermal Resistance, Junction-to-Ambient (typical socket mount)	—	—	40	
	Weight	—	6.0 (0.21)	—	g (oz)

Electrical Characteristics @ T_J = 25°C (unless otherwise specified)

Parameter	Min.	Typ.	Max.	Units	Conditions	Ref.Fig	
V _{(BR)CES}	600	—	—	V	V _{GE} = 0V, I _C = 500μA		
ΔV _{(BR)CES} /ΔT _J	—	0.78	—	V/°C	V _{GE} = 0V, I _C = 1mA (25°C-125°C)		
R _G	—	1.7	—	Ω	1MHz, Open Collector		
V _{CE(on)}	Collector-to-Emitter Saturation Voltage	—	1.85	2.15	V	I _C = 22A, V _{GE} = 15V	4, 5, 6, 8, 9
		—	2.25	2.55		I _C = 35A, V _{GE} = 15V	
		—	2.37	2.80		I _C = 22A, V _{GE} = 15V, T _J = 125°C	
		—	3.00	3.45		I _C = 35A, V _{GE} = 15V, T _J = 125°C	
V _{GE(th)}	3.0	4.0	5.0	V	I _C = 250μA	7, 8, 9	
ΔV _{GE(th)} /ΔT _J	—	-10	—	mV/°C	V _{CE} = V _{GE} , I _C = 1.0mA		
g _{fe}	—	36	—	S	V _{CE} = 50V, I _C = 22A, PW = 80μs		
I _{CES}	Collector-to-Emitter Leakage Current	—	3.0	375	μA	V _{GE} = 0V, V _{CE} = 600V	
		—	0.35	—	mA	V _{GE} = 0V, V _{CE} = 600V, T _J = 125°C	
V _{FM}	Diode Forward Voltage Drop	—	1.30	1.70	V	I _F = 15A, V _{GE} = 0V	10
		—	1.20	1.60		I _F = 15A, V _{GE} = 0V, T _J = 125°C	
I _{GES}	Gate-to-Emitter Leakage Current	—	—	±100	nA	V _{GE} = ±20V, V _{CE} = 0V	

Switching Characteristics @ T_J = 25°C (unless otherwise specified)

Parameter	Min.	Typ.	Max.	Units	Conditions	Ref.Fig	
Q _g	—	160	240	nC	I _C = 22A	17	
Q _{gc}	—	55	83		V _{CC} = 400V	CT1	
Q _{ge}	—	21	32		V _{GE} = 15V		
E _{on}	—	220	270	μJ	I _C = 22A, V _{CC} = 390V	CT3	
E _{off}	—	215	265		V _{GE} = +15V, R _G = 3.3Ω, L = 200μH		
E _{total}	—	435	535		T _J = 25°C ⊕		
t _{d(on)}	—	26	34	ns	I _C = 22A, V _{CC} = 390V	CT3	
t _r	—	6.0	8.0		V _{GE} = +15V, R _G = 3.3Ω, L = 200μH		
t _{d(off)}	—	110	122		T _J = 25°C ⊕		
t _f	—	8.0	10	μJ	I _C = 22A, V _{CC} = 390V	CT3	
E _{on}	—	410	465		V _{GE} = +15V, R _G = 3.3Ω, L = 200μH		
E _{off}	—	330	405		T _J = 125°C ⊕		
E _{total}	—	740	870	ns	I _C = 22A, V _{CC} = 390V	CT3	
t _{d(on)}	—	26	34		V _{GE} = +15V, R _G = 3.3Ω, L = 200μH		
t _r	—	8.0	11		T _J = 125°C ⊕		
t _{d(off)}	—	130	150	pF	I _C = 22A, V _{CC} = 390V	WF1, WF2	
t _f	—	12	16		V _{GE} = 0V		
C _{ies}	—	3715	—		V _{CC} = 30V		
C _{oes}	—	265	—	pF	f = 1Mhz	16	
C _{res}	—	47	—		V _{GE} = 0V, V _{CE} = 0V to 480V		
C _{oes eff.}	—	135	—				
C _{oes eff. (ER)}	—	179	—		15		
RBSOA	Reverse Bias Safe Operating Area	FULL SQUARE				T _J = 150°C, I _C = 120A V _{CC} = 480V, V _p = 600V R _g = 22Ω, V _{GE} = +15V to 0V	3 CT2
t _{rr}	Diode Reverse Recovery Time	—	42	60	ns	T _J = 25°C I _F = 15A, V _R = 200V,	19
		—	74	120		T _J = 125°C di/dt = 200A/μs	
Q _{rr}	Diode Reverse Recovery Charge	—	80	180	nC	T _J = 25°C I _F = 15A, V _R = 200V,	21
		—	220	600		T _J = 125°C di/dt = 200A/μs	
I _{rr}	Peak Reverse Recovery Current	—	4.0	6.0	A	T _J = 25°C I _F = 15A, V _R = 200V,	19, 20, 21, 22
		—	6.5	10		T _J = 125°C di/dt = 200A/μs	

Notes:

- ① R_{CE(on)} typ. = equivalent on-resistance = V_{CE(on)} typ. / I_C, where V_{CE(on)} typ. = 1.85V and I_C = 22A. I_D (FET Equivalent) is the equivalent MOSFET I_D rating @ 25°C for applications up to 150kHz. These are provided for comparison purposes (only) with equivalent MOSFET solutions.
- ② V_{CC} = 80% (V_{CES}), V_{GE} = 20V, L = 100 μH, R_G = 3.3Ω.
- ③ Pulse width limited by max. junction temperature.
- ④ Energy losses include "tail" and diode reverse recovery, Data generated with use of Diode 30ETH06.
- ⑤ C_{oes eff.} is a fixed capacitance that gives the same charging time as C_{oes} while V_{CE} is rising from 0 to 80% V_{CES}.
C_{oes eff. (ER)} is a fixed capacitance that stores the same energy as C_{oes} while V_{CE} is rising from 0 to 80% V_{CES}.

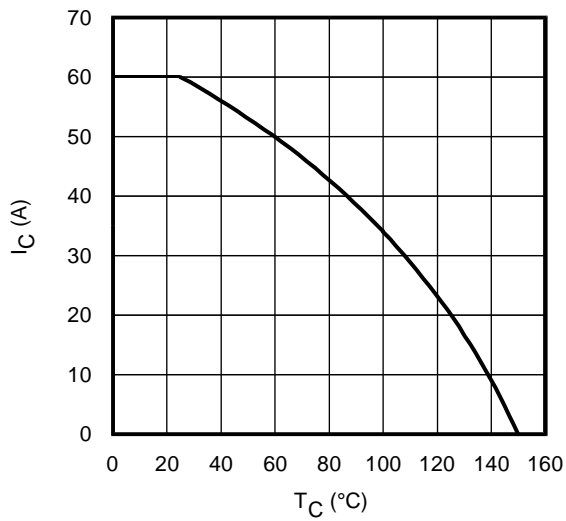

Fig. 1 - Maximum DC Collector Current vs. Case Temperature

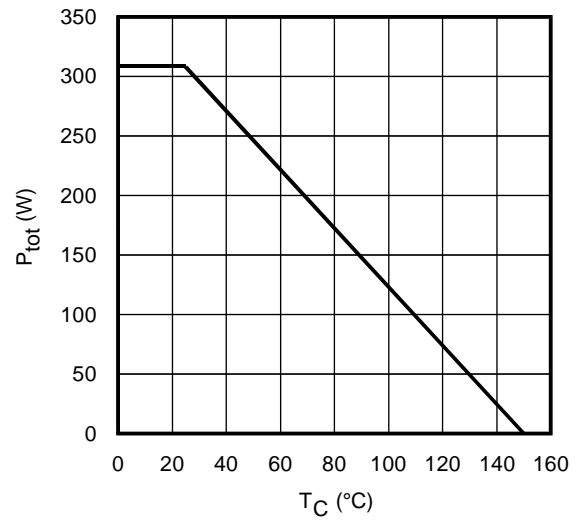

Fig. 2 - Power Dissipation vs. Case Temperature

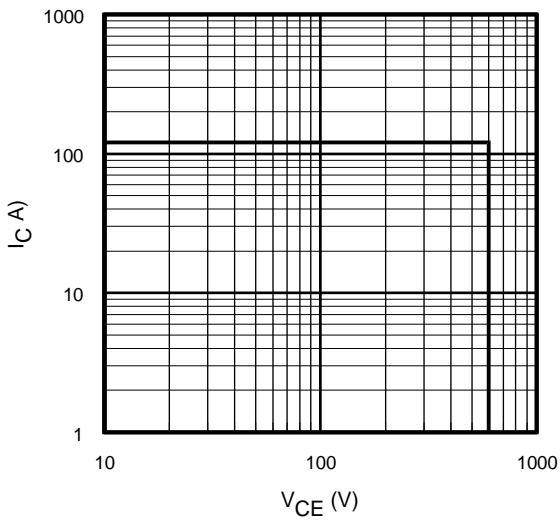

Fig. 3 - Reverse Bias SOA
 $T_J = 150^\circ\text{C}$; $V_{GE} = 15\text{V}$

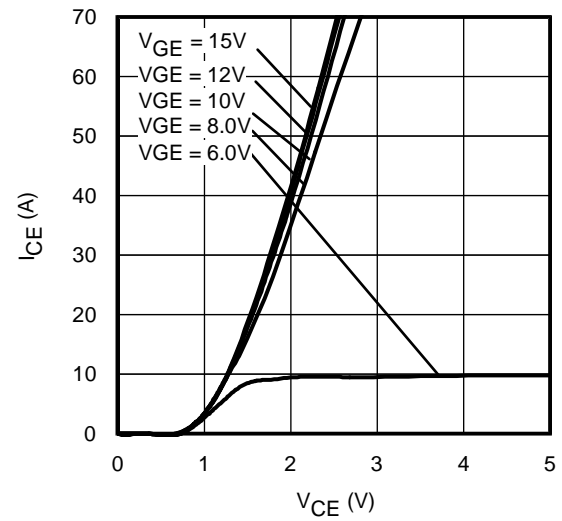

Fig. 4 - Typ. IGBT Output Characteristics
 $T_J = -40^\circ\text{C}$; $t_p = 80\mu\text{s}$

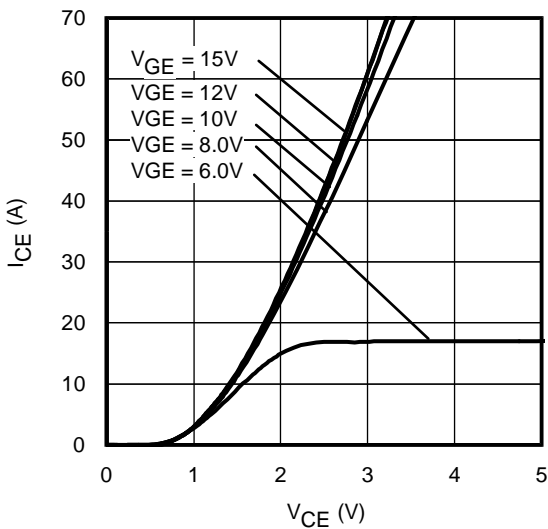

Fig. 5 - Typ. IGBT Output Characteristics
 $T_J = 25^\circ\text{C}$; $t_p = 80\mu\text{s}$

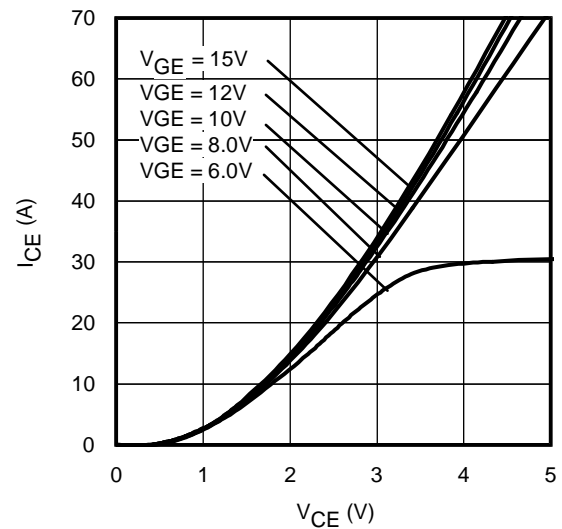

Fig. 6 - Typ. IGBT Output Characteristics
 $T_J = 125^\circ\text{C}$; $t_p = 80\mu\text{s}$

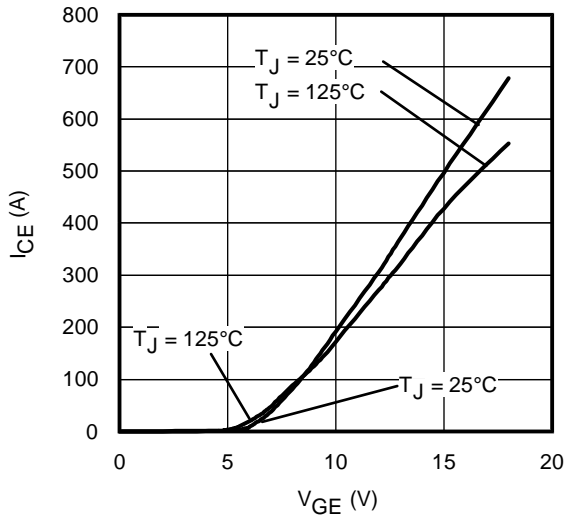

Fig. 7 - Typ. Transfer Characteristics
 $V_{CE} = 50V$; $t_p = 10\mu s$

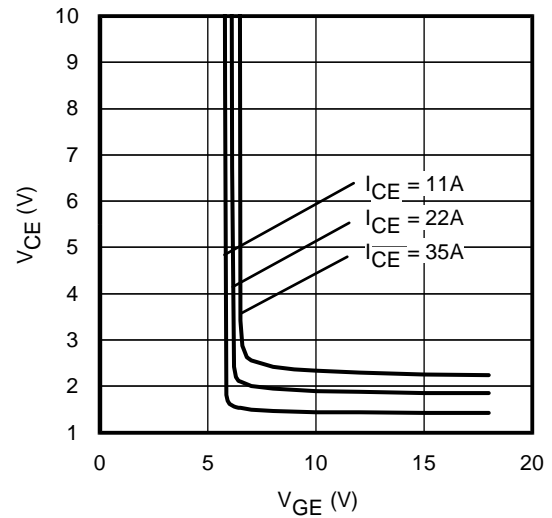

Fig. 8 - Typical V_{CE} vs. V_{GE}
 $T_J = 25^\circ C$

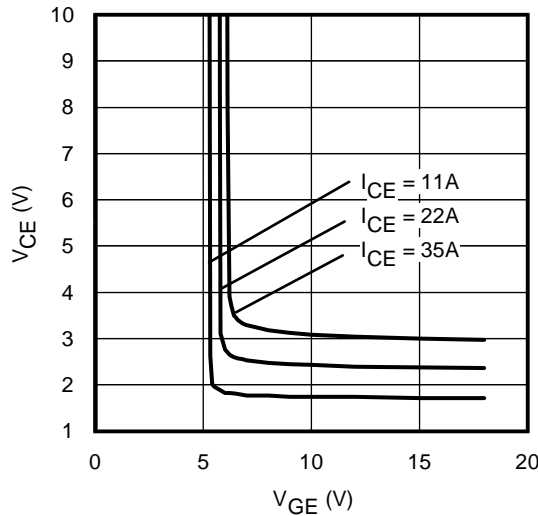

Fig. 9 - Typical V_{CE} vs. V_{GE}
 $T_J = 125^\circ C$

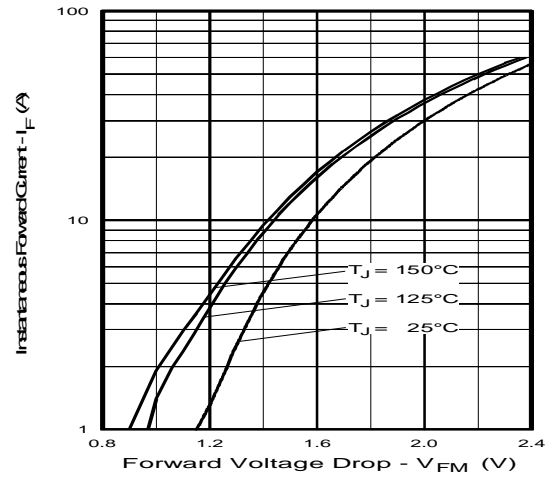

Fig. 10 - Typ. Diode Forward Characteristics
 $t_p = 80\mu s$

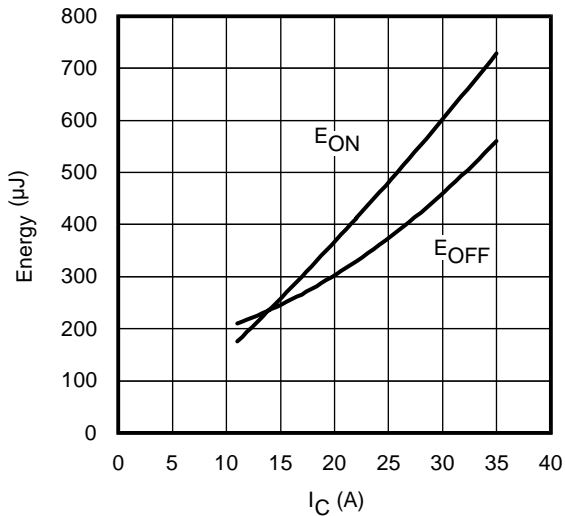

Fig. 11 - Typ. Energy Loss vs. I_C
 $T_J = 125^\circ C$; $L = 200\mu H$; $V_{CE} = 390V$, $R_G = 3.3\Omega$; $V_{GE} = 15V$.
Diode clamp used: 30ETH06 (See C.T.3)

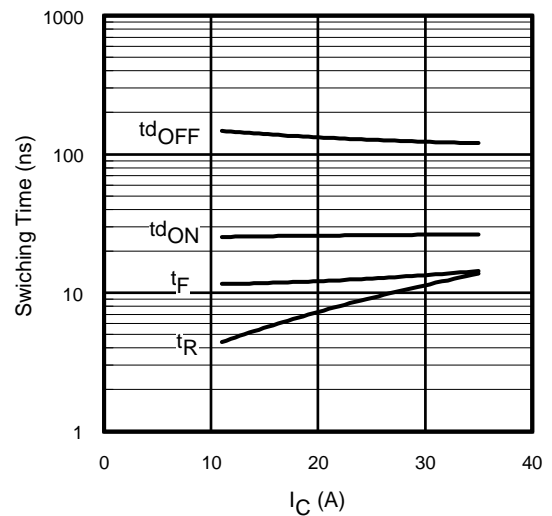

Fig. 12 - Typ. Switching Time vs. I_C
 $T_J = 125^\circ C$; $L = 200\mu H$; $V_{CE} = 390V$, $R_G = 3.3\Omega$; $V_{GE} = 15V$.
Diode clamp used: 30ETH06 (See C.T.3)

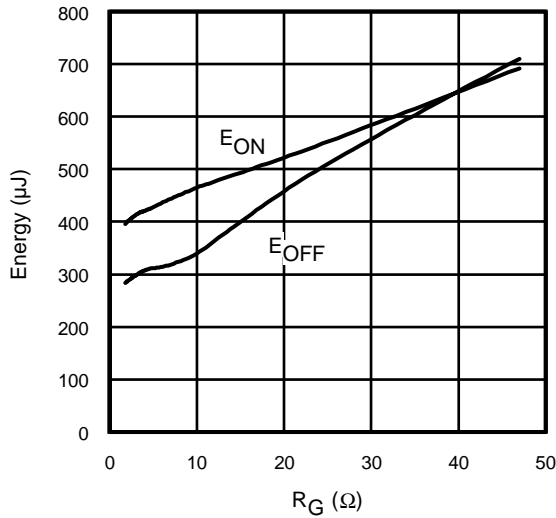

Fig. 13 - Typ. Energy Loss vs. R_G
 $T_J = 125^\circ\text{C}$; $L = 200\mu\text{H}$; $V_{CE} = 390\text{V}$; $I_{CE} = 22\text{A}$; $V_{GE} = 15\text{V}$
 Diode clamp used: 30ETH06 (See C.T.3)

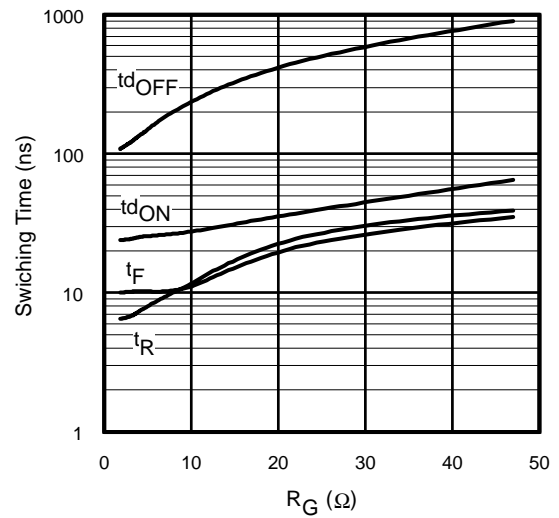
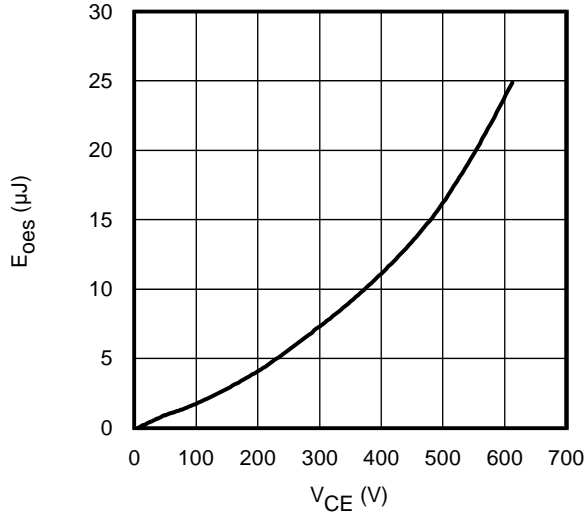

Fig. 14 - Typ. Switching Time vs. R_G
 $T_J = 125^\circ\text{C}$; $L = 200\mu\text{H}$; $V_{CE} = 390\text{V}$; $I_{CE} = 22\text{A}$; $V_{GE} = 15\text{V}$
 Diode clamp used: 30ETH06 (See C.T.3)



**Fig. 15- Typ. Output Capacitance
 Stored Energy vs. V_{CE}**

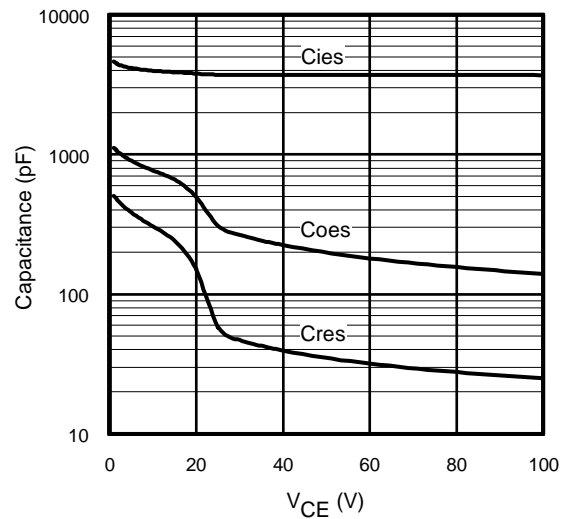

Fig. 16- Typ. Capacitance vs. V_{CE}
 $V_{GE} = 0\text{V}$; $f = 1\text{MHz}$

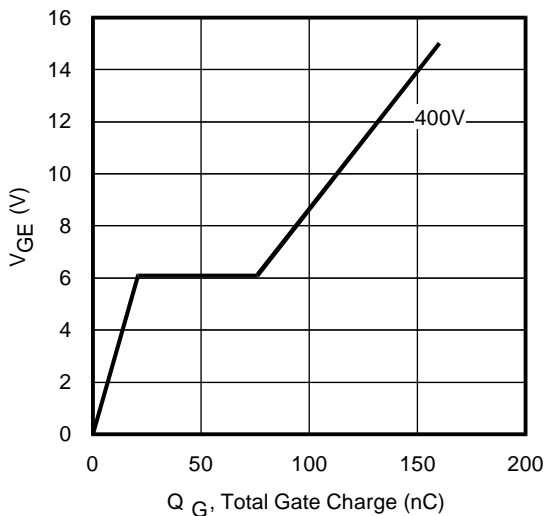
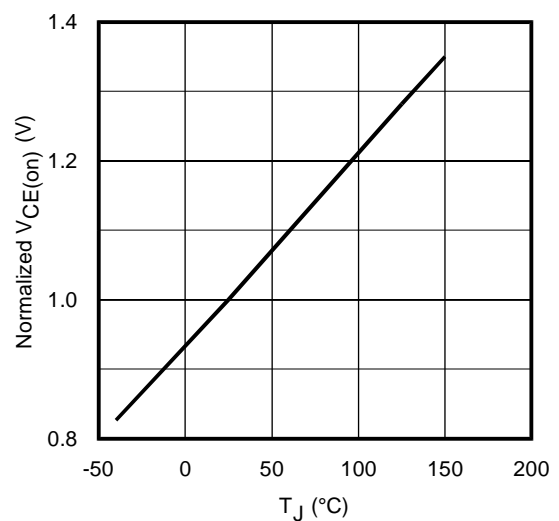

Fig. 17 - Typical Gate Charge vs. V_{GE}
 $I_{CE} = 22\text{A}$



**Fig. 18 - Normalized Typ. $V_{CE(on)}$
 vs. Junction Temperature**
 $I_C = 22\text{A}$, $V_{GE} = 15\text{V}$

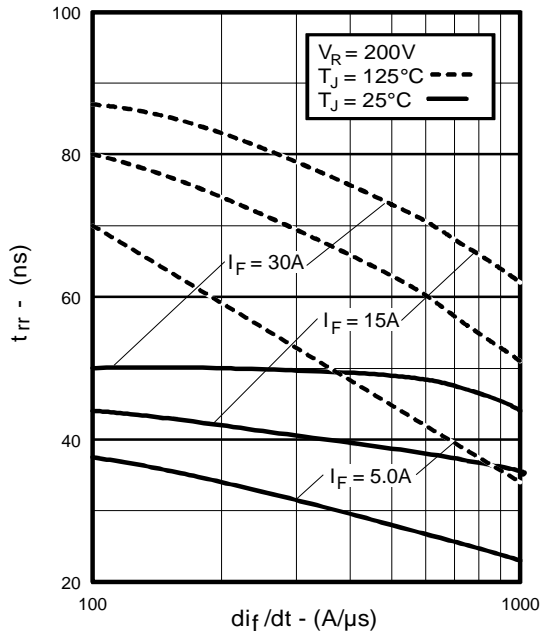

Fig. 19 - Typical Reverse Recovery vs. di_f/dt

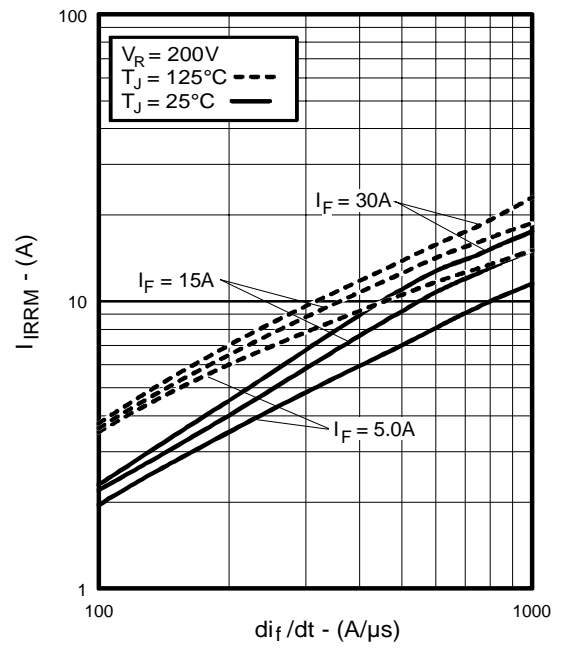

Fig. 20 - Typical Recovery Current vs. di_f/dt

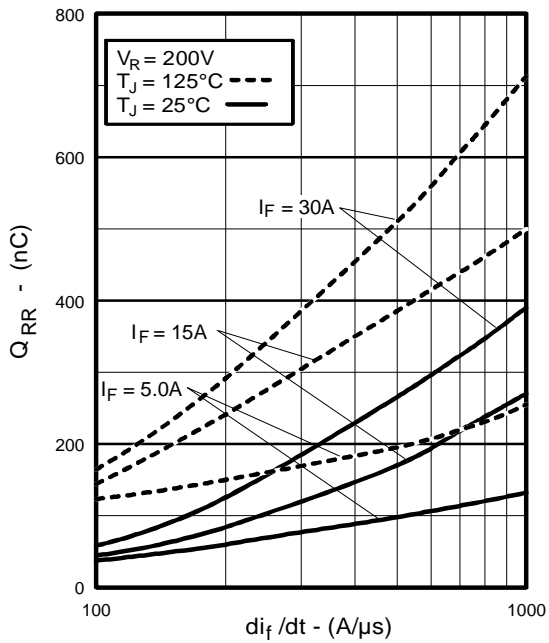

Fig. 21 - Typical Stored Charge vs. di_f/dt

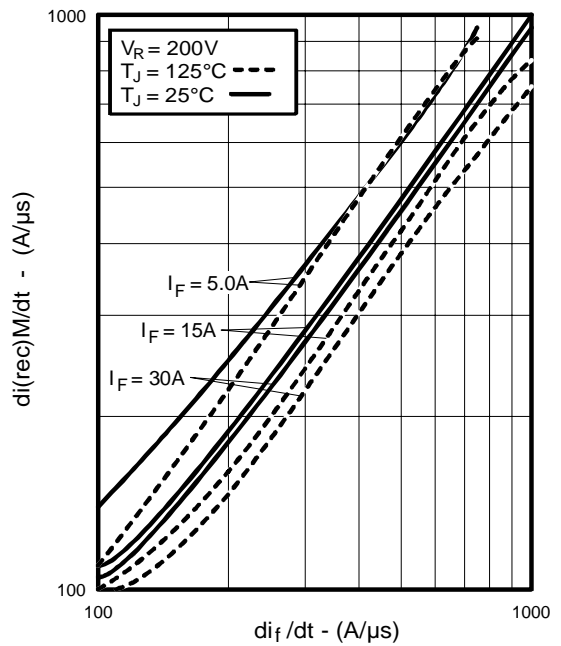

Fig. 22 - Typical $di_{(rec)M}/dt$ vs. di_f/dt

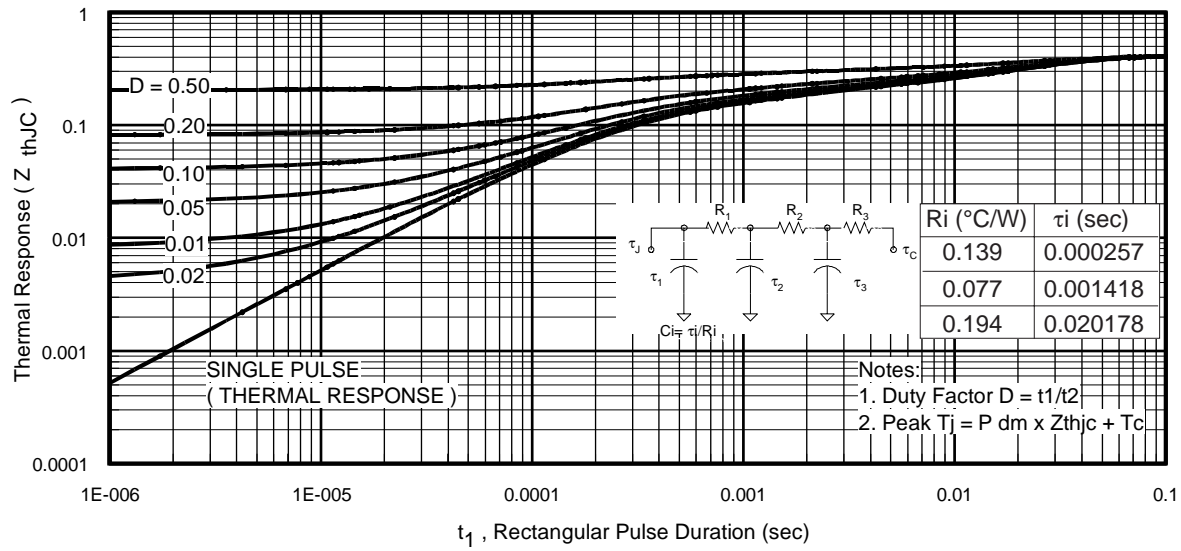

Fig 23. Maximum Transient Thermal Impedance, Junction-to-Case (IGBT)

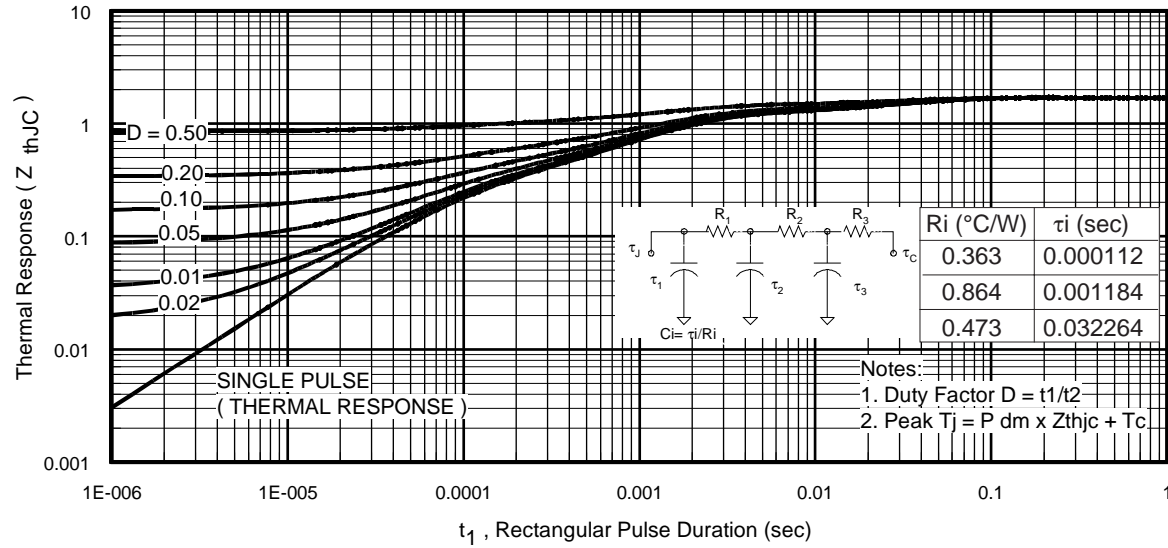

Fig. 24. Maximum Transient Thermal Impedance, Junction-to-Case (DIODE)

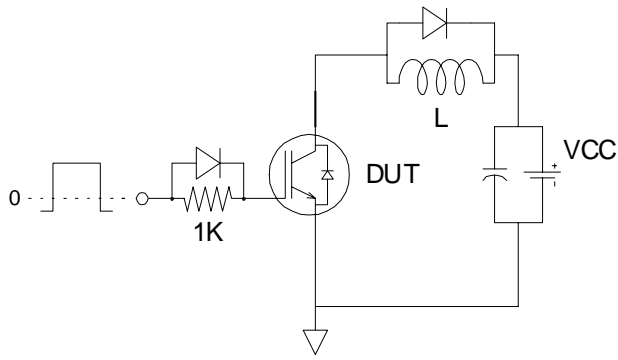

Fig.C.T.1 - Gate Charge Circuit (turn-off)

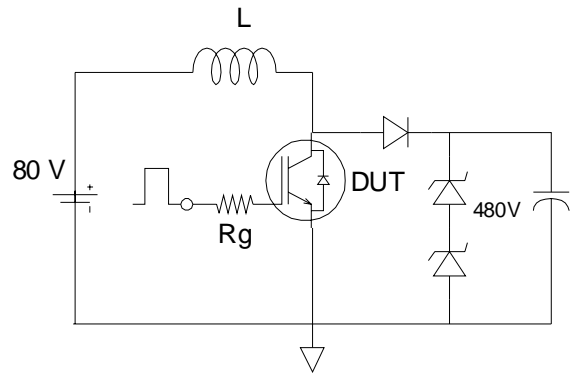

Fig.C.T.2 - RBSOA Circuit

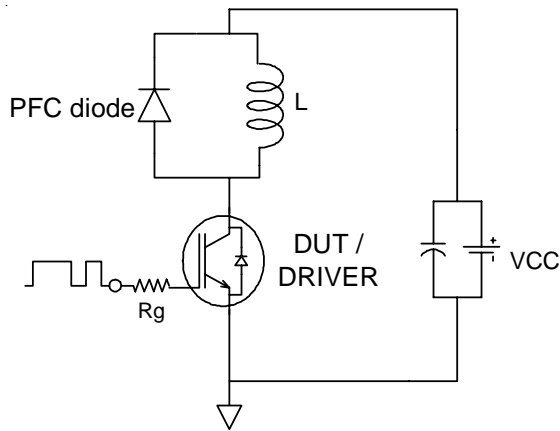

Fig.C.T.3 - Switching Loss Circuit

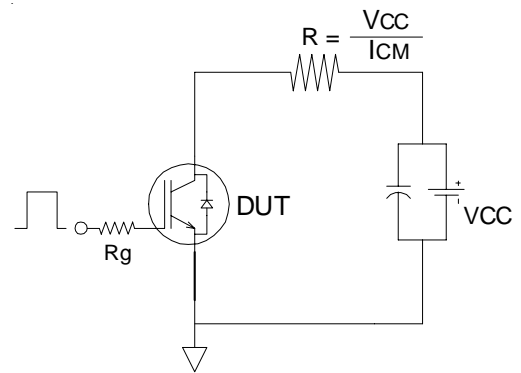

Fig.C.T.4 - Resistive Load Circuit

REVERSE RECOVERY CIRCUIT

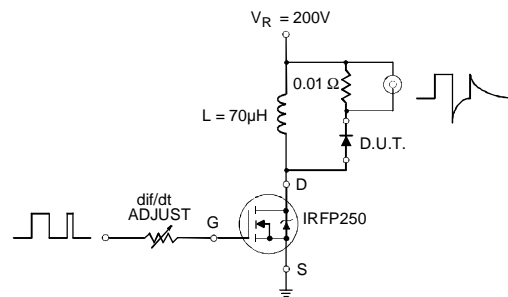

Fig. C.T.5 - Reverse Recovery Parameter Test Circuit

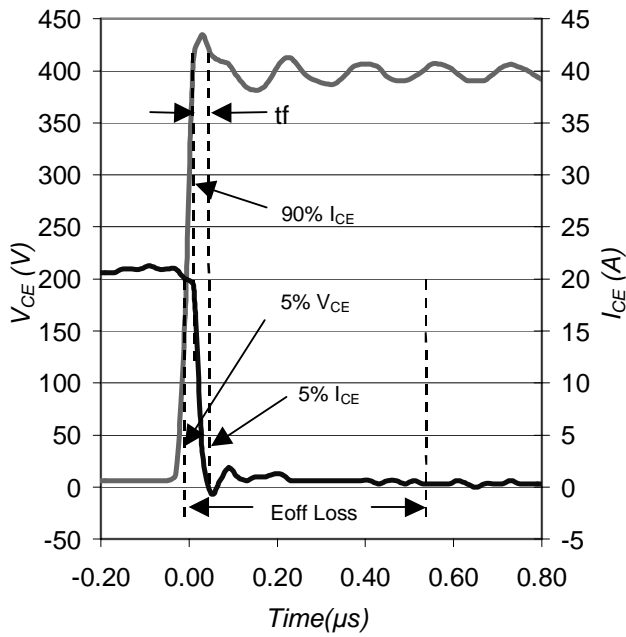

Fig. WF1 - Typ. Turn-off Loss Waveform
@ $T_J = 25^\circ\text{C}$ using Fig. CT.3

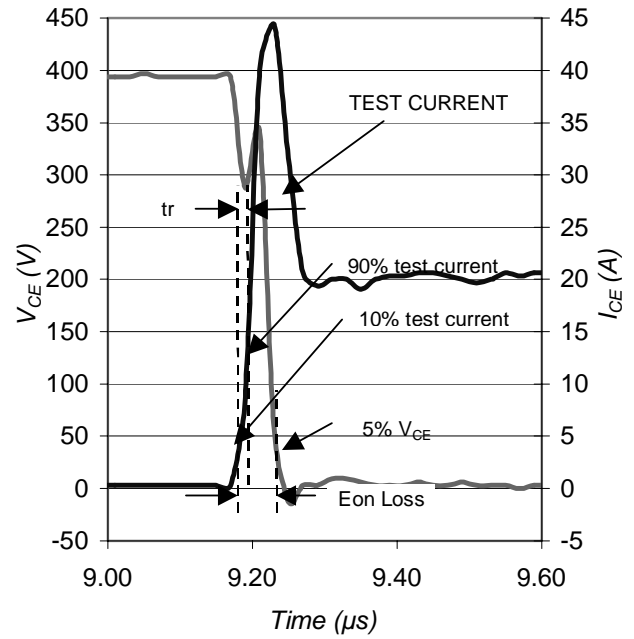
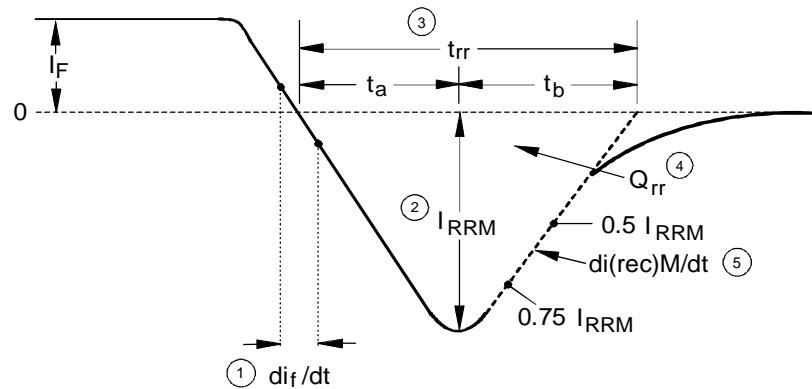

Fig. WF2 - Typ. Turn-on Loss Waveform
@ $T_J = 25^\circ\text{C}$ using Fig. CT.3



1. di_f/dt - Rate of change of current through zero crossing
2. I_{RRM} - Peak reverse recovery current
3. t_{rr} - Reverse recovery time measured from zero crossing point of negative going I_F to point where a line passing through $0.75 I_{RRM}$ and $0.50 I_{RRM}$ extrapolated to zero current

4. Q_{rr} - Area under curve defined by t_{rr} and I_{RRM}

$$Q_{rr} = \frac{t_{rr} \times I_{RRM}}{2}$$
5. $di_{(rec)M}/dt$ - Peak rate of change of current during t_b portion of t_{rr}

Fig. WF3 - Reverse Recovery Waveform and Definitions

TO-247AC Package Outline Dimensions are shown in millimeters (inches)

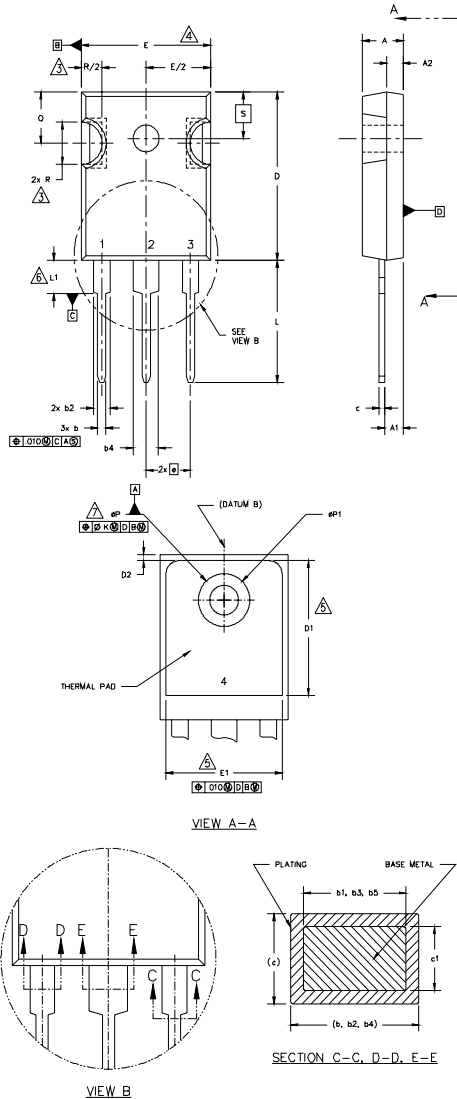

NOTES:

- DIMENSIONING AND TOLERANCING PER ASME Y14.5M 1994.
- DIMENSIONS ARE SHOWN IN INCHES [MILLIMETERS]
- CONTOUR OF SLOT OPTIONAL.
- DIMENSION D & E DO NOT INCLUDE MOLD FLASH. MOLD FLASH SHALL NOT EXCEED .005" (0.127) PER SIDE. THESE DIMENSIONS ARE MEASURED AT THE OUTERMOST EXTREMES OF THE PLASTIC BODY.
- THERMAL PAD CONTOUR OPTIONAL WITHIN DIMENSIONS D1 & E1.
- LEAD FINISH UNCONTROLLED IN L1.
- ØP TO HAVE A MAXIMUM DRAFT ANGLE OF 1.5 ° TO THE TOP OF THE PART WITH A MAXIMUM HOLE DIAMETER OF .154" [3.91].
- OUTLINE CONFORMS TO JEDEC OUTLINE TO-247 WITH THE EXCEPTION OF DIMENSION c.

SYMBOL	DIMENSIONS				NOTES
	INCHES		MILLIMETERS		
	MIN.	MAX.	MIN.	MAX.	
A	.183	.209	4.65	5.31	
A1	.087	.102	2.21	2.59	
A2	.059	.098	1.50	2.49	
b	.039	.055	0.99	1.40	
b1	.039	.053	0.99	1.35	
b2	.065	.094	1.65	2.39	
b3	.065	.092	1.65	2.37	
b4	.102	.135	2.59	3.43	
b5	.102	.133	2.59	3.38	
c	.015	.034	0.38	0.86	
c1	.015	.030	0.38	0.76	
D	.776	.815	19.71	20.70	4
D1	.515	-	13.08	-	5
D2	.020	.030	0.51	0.76	
E	.602	.625	15.29	15.87	4
E1	.540	-	15.72	-	
e	.215 BSC		5.46 BSC		
Øk	.010		2.54		
L	.559	.634	14.20	16.10	
L1	.146	.169	3.71	4.29	
N	3		7.62 BSC		
ØP	.140	.144	3.56	3.66	
ØP1	-	.275	-	6.98	
Q	.209	.224	5.31	5.69	
R	.178	.216	4.52	5.49	
S	.217 BSC		5.51 BSC		

LEAD ASSIGNMENTS

HEXFET

- GATE
- DRAIN
- SOURCE
- DRAIN

IGBTs, CoPACK

- GATE
- COLLECTOR
- EMITTER
- COLLECTOR

DIODES

- ANODE/OPEN
- CATHODE
- ANODE

TO-247AC Part Marking Information

EXAMPLE: THIS IS AN IRFPE30 WITH ASSEMBLY LOT CODE 5657 ASSEMBLED ON WW 35, 2000 IN THE ASSEMBLY LINE "H"

Note: "P" in assembly line position indicates "Lead-Free"

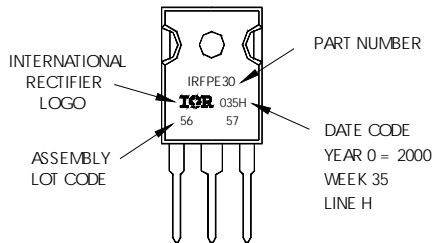

Data and specifications subject to change without notice. This product has been designed and qualified for Industrial market. Qualification Standards can be found on IR's Web site.

Note: For the most current drawings please refer to the IR website at:
<http://www.irf.com/package/>